

Mechanical:

REV.	ECN NO.	DESCRIPTION	DATE	APPD
A	REL		2010/07/15	

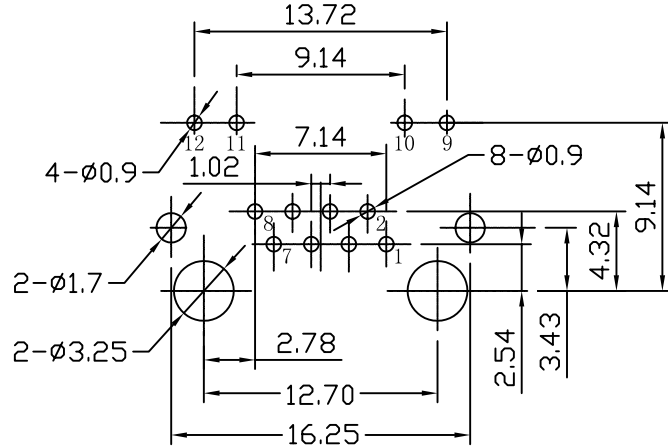

PC Board Layout (TOP VIEW)

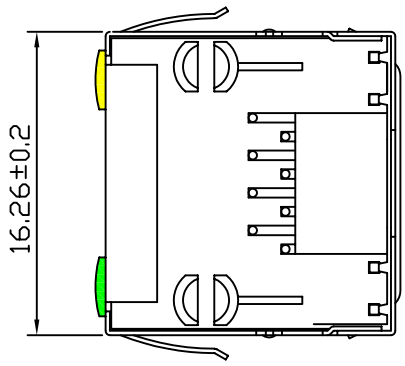
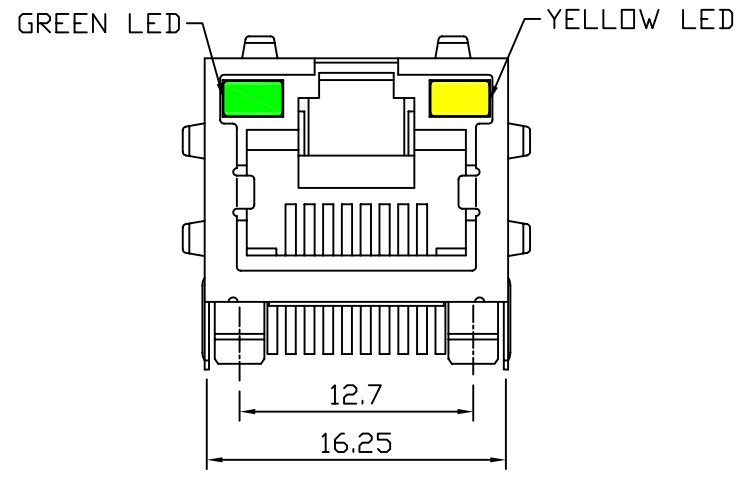
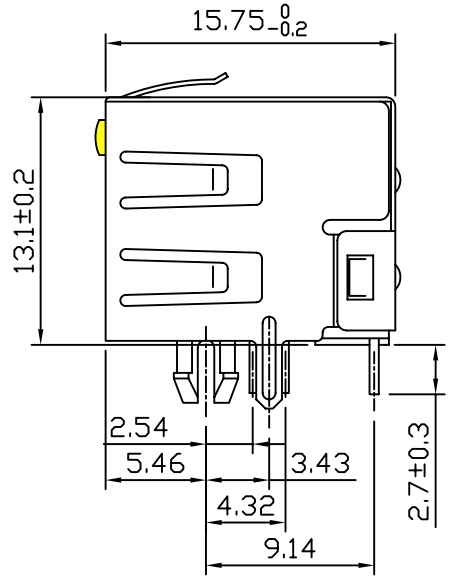

NOTES:

- PCB JACK Specification
1. Insulation Resistance: 500MΩ MIN @ 500 VDC
 2. Withstanding Voltage: AC1000V 50Hz or 60Hz 1min.
 3. Durability: 600 Mating Circles MIN.
 4. Gold Plating:
(Gold Flash; 1.5; 3; 6; 15; 30; 50)u" inch

ENVIRONMENTAL

1. Storage Temperature: -40°C To +85°C
2. Operation Temperature: -40°C To +85°C
3. Wave Soldering Temperature:
255°C ~ 265°C (5 ~ 10 Seconds)
4. RoHS Compliant.

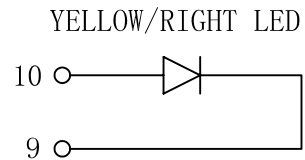
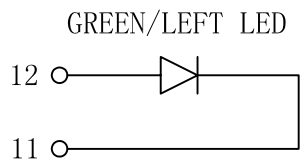
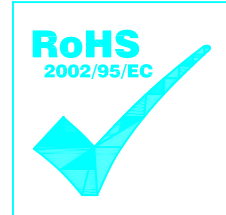

X:X ±0.25	APPD:	LINK-PP INT'L TECHNOLOGY CO., LIMITED		
X:XX ±0.10	CHKD:	TITLE: RJ45 1×1 CONNECTOR		
X:XXX ±0.05	DR: TOM	PART NO.: LPJE101AHNL		
ANGLES ±1°	UNIT: mm	REV: A		
	SCALE: 2/1	SHEET: 1/1	DWG NO.: LP10071505	